



Ceiba AT 25

CONDO PARADISE



El Paraíso en tu casa



La inversión patrimonial con más estilo en *Playa del Carmen* está en *Ceiba at 25 Condo Paradise*, un exclusivo proyecto de departamentos que eleva los estándares de diseño, lujo y comodidad en los desarrollos a lo largo de la Riviera Maya.

Al interior, *un paraíso* te espera con lujosas habitaciones y áreas comunes, con nuestra majestuosa Ceiba como protagonista que no sólo te quitarán el aliento, te harán pensar dos veces antes de salir de casa.



Amenidades





Alberca Infinita

Restaurante

Alberca Infinita

Gimnasio

Pool Bar

Estacionamiento

Salón de usos múltiples



Alberca Infinita y Pool Bar con vistas panorámicas



Pool Bar



*Roof top con vista interior a nuestra Ceiba,
brindándole vida a las áreas comunes.*

Master Plan





6 NIVELES
92 UNIDADES, DESDE 52 M²
1, 2 Y 3 RECÁMARAS



Sala comedor



Comedor



Recámara Principal



Recámara Secundaria

The background of the slide features two images of citrus fruits. The top image shows a slice of grapefruit with vibrant red segments, resting on a silver plate with an ornate, embossed floral border. The bottom image shows a whole orange being cut with a knife, with the knife's blade visible at the bottom of the frame. The orange is bright yellow and sits on a dark surface.

Tipo de Departamentos

Departamento Tipo A1



Departamento Tipo A1

Tipo	A1
Habitaciones	2
Baño	2
Terraza Techada	7.14 m ²
Terraza no Techada	0 m ²
Superficie Interior	85.70 m ²
Total de superficie	92.84 m ²

Planta alta

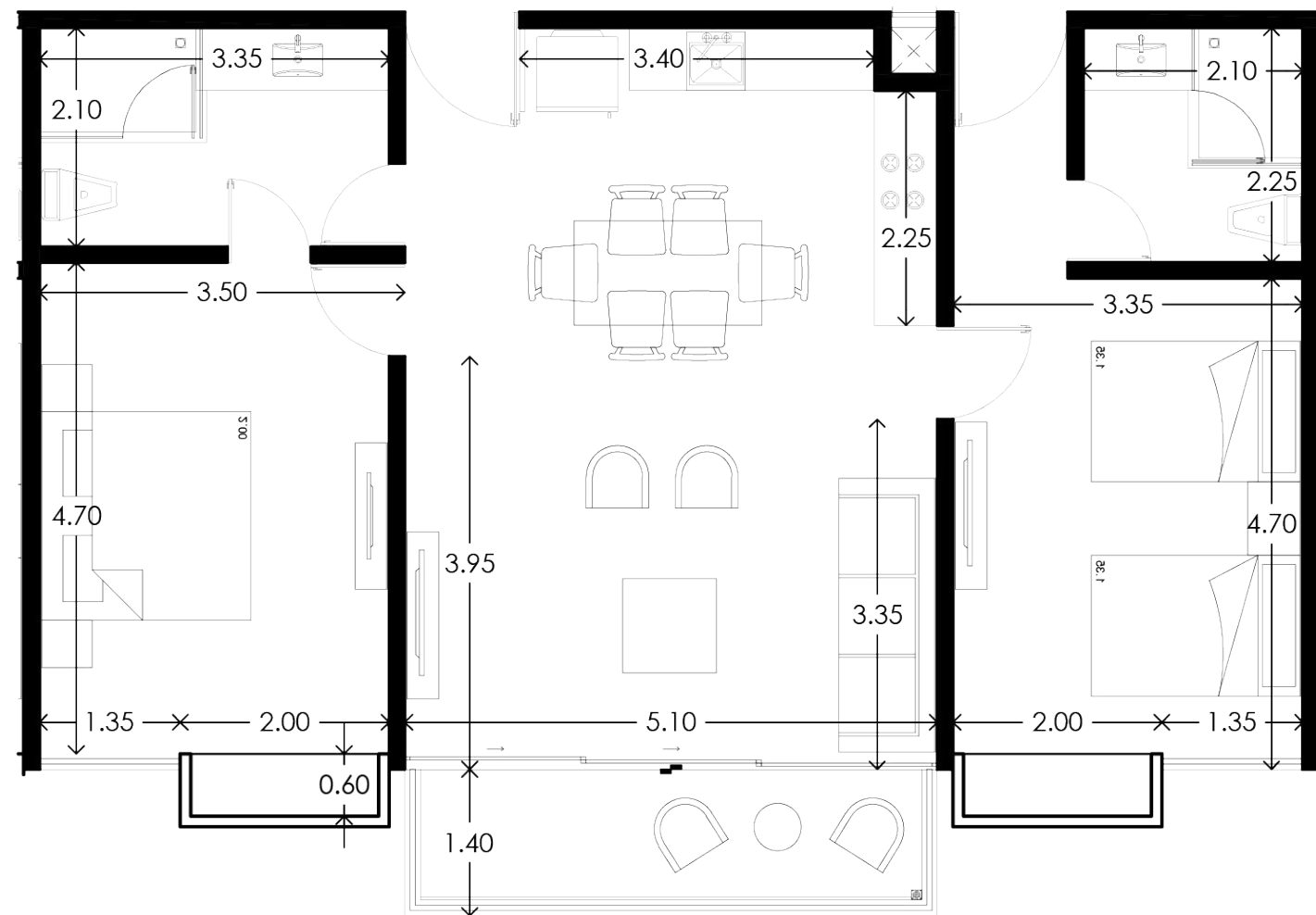

Departamento Tipo A2



Departamento Tipo A2

Tipo	A2
Habitaciones	2
Baño	2
Terraza Techada	5.10 m ²
Terraza no Techada	0 m ²
Superficie Interior	76.55 m ²
Total de superficie	81.65 m ²

Planta alta

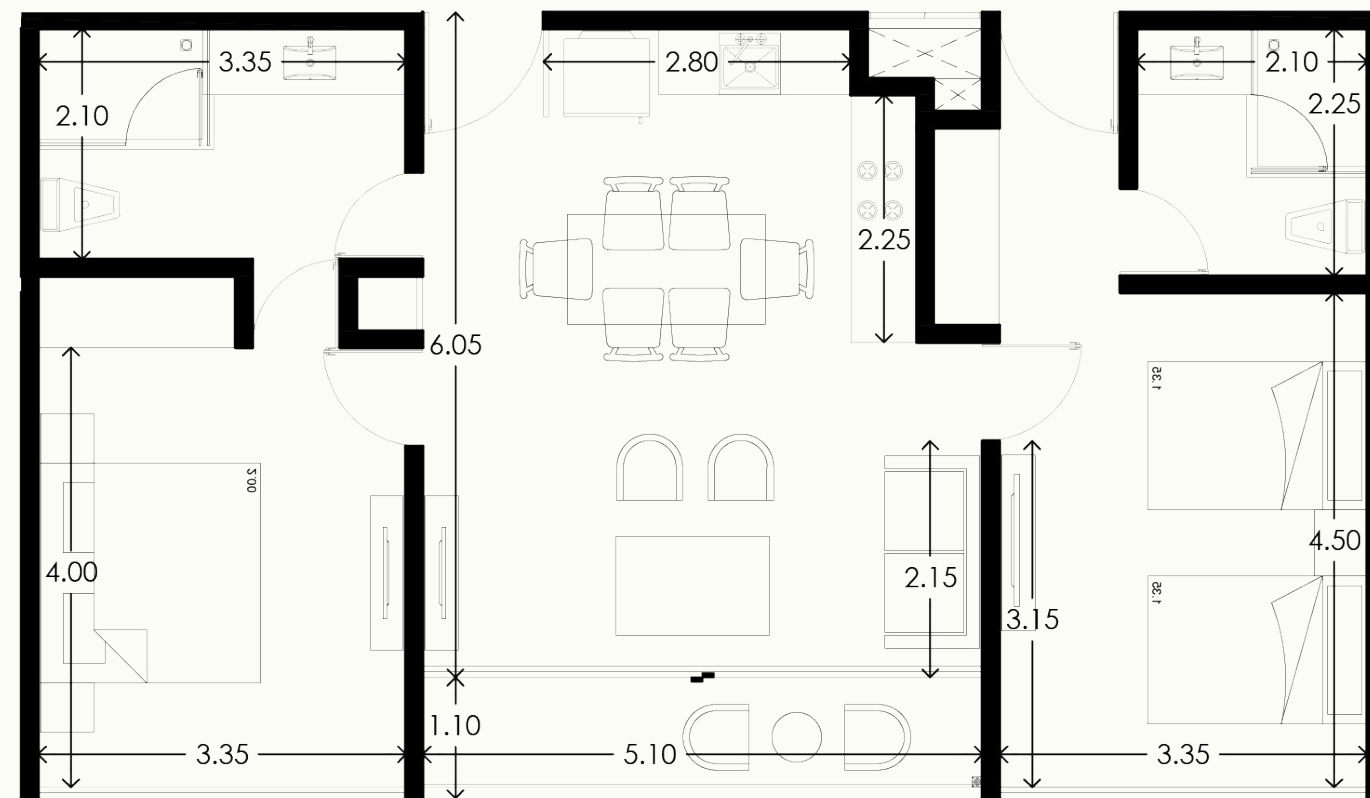

Departamento Tipo B1



Departamento Tipo B1

Tipo	B1
Habitaciones	1
Baño	1
Terraza Techada	7.14 m ²
Terraza no Techada	0 m ²
Superficie Interior	60.85 m ²
Total de superficie	67.99 m ²

Planta alta

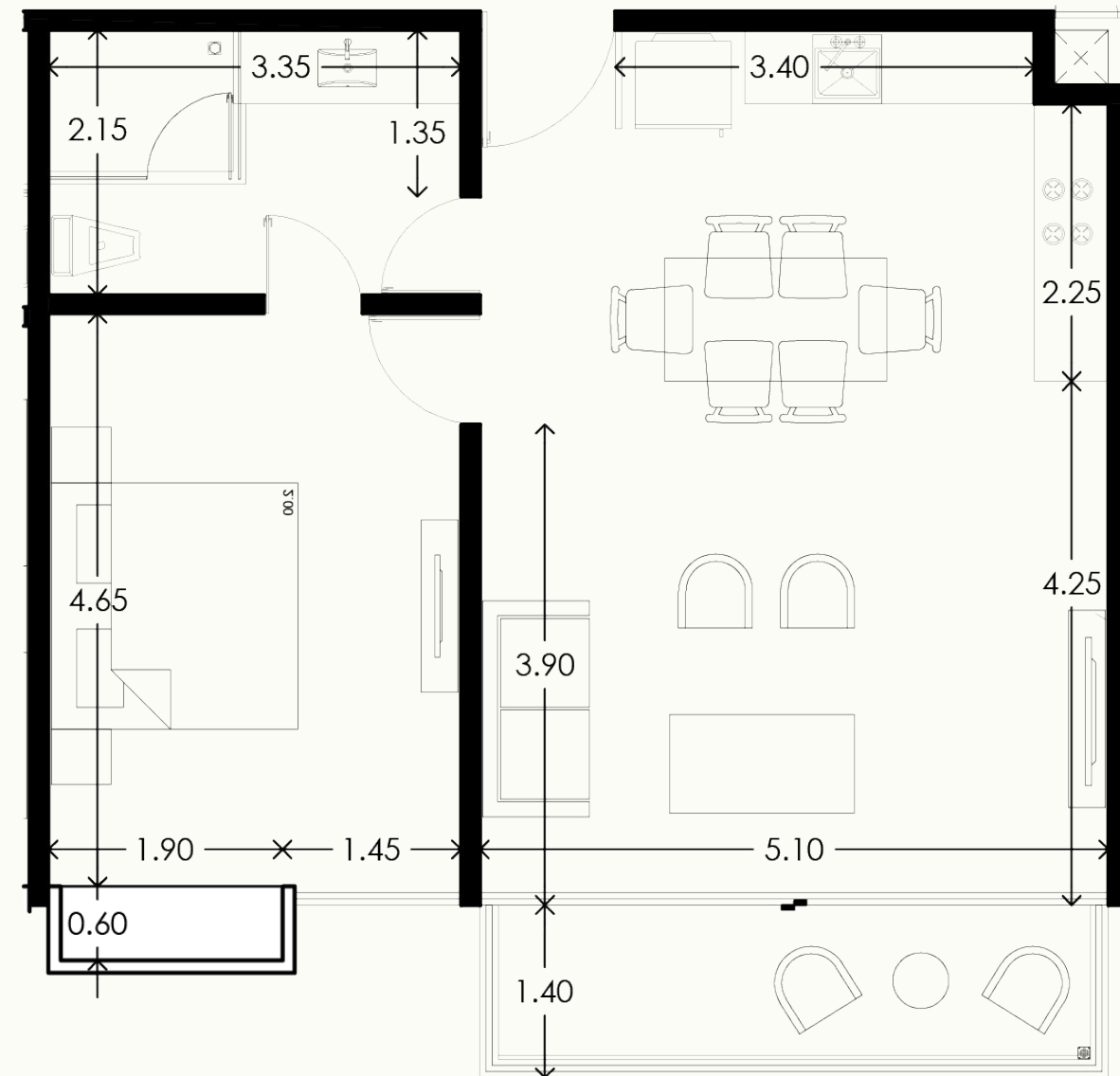
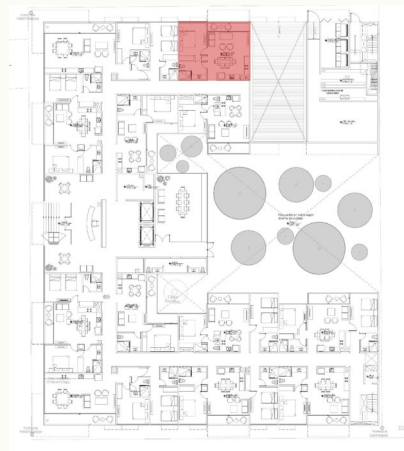

Departamento Tipo C1



Departamento Tipo C1

Tipo	C1
Habitaciones	3
Baño	3
Terraza Techada	15.20 m ²
Terraza no Techada	0 m ²
Superficie Interior	111.25 m ²
Total de superficie	126.45 m ²

Planta alta

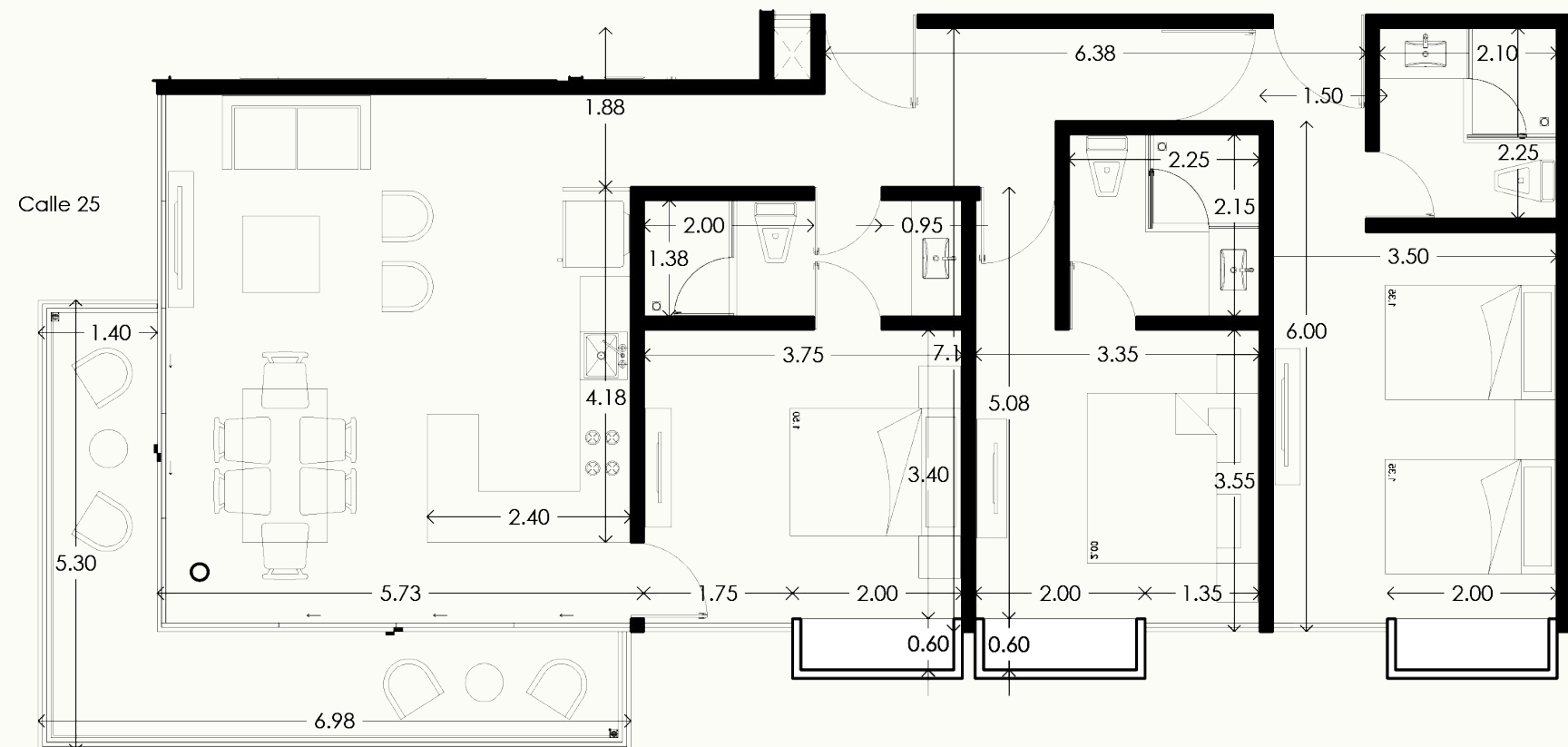

Departamento Tipo Y1



Departamento Tipo Y1

Tipo	Y1
Habitaciones	2
Baño	2
Terraza Techada	6.88 m ²
Terraza no Techada	0 m ²
Superficie Interior	70.20 m ²
Total de superficie	77.08 m ²

Planta alta

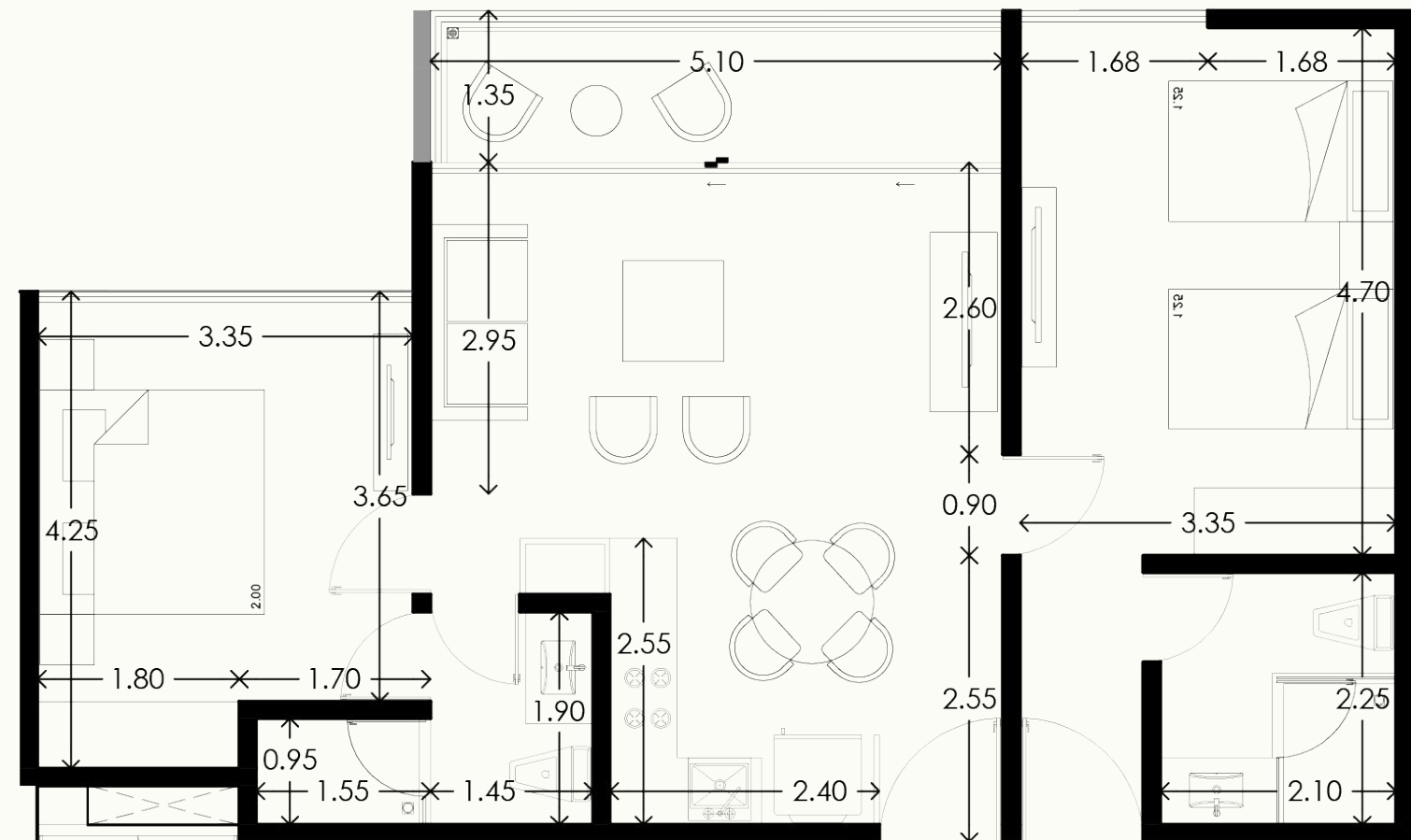

Departamento Tipo Z



Departamento Tipo Z

Tipo	Z
Habitaciones	1
Baño	1
Terraza Techada	10.90 m ²
Terraza no Techada	0 m ²
Superficie Interior	47.40 m ²
Total de superficie	58.30 m ²

Planta alta

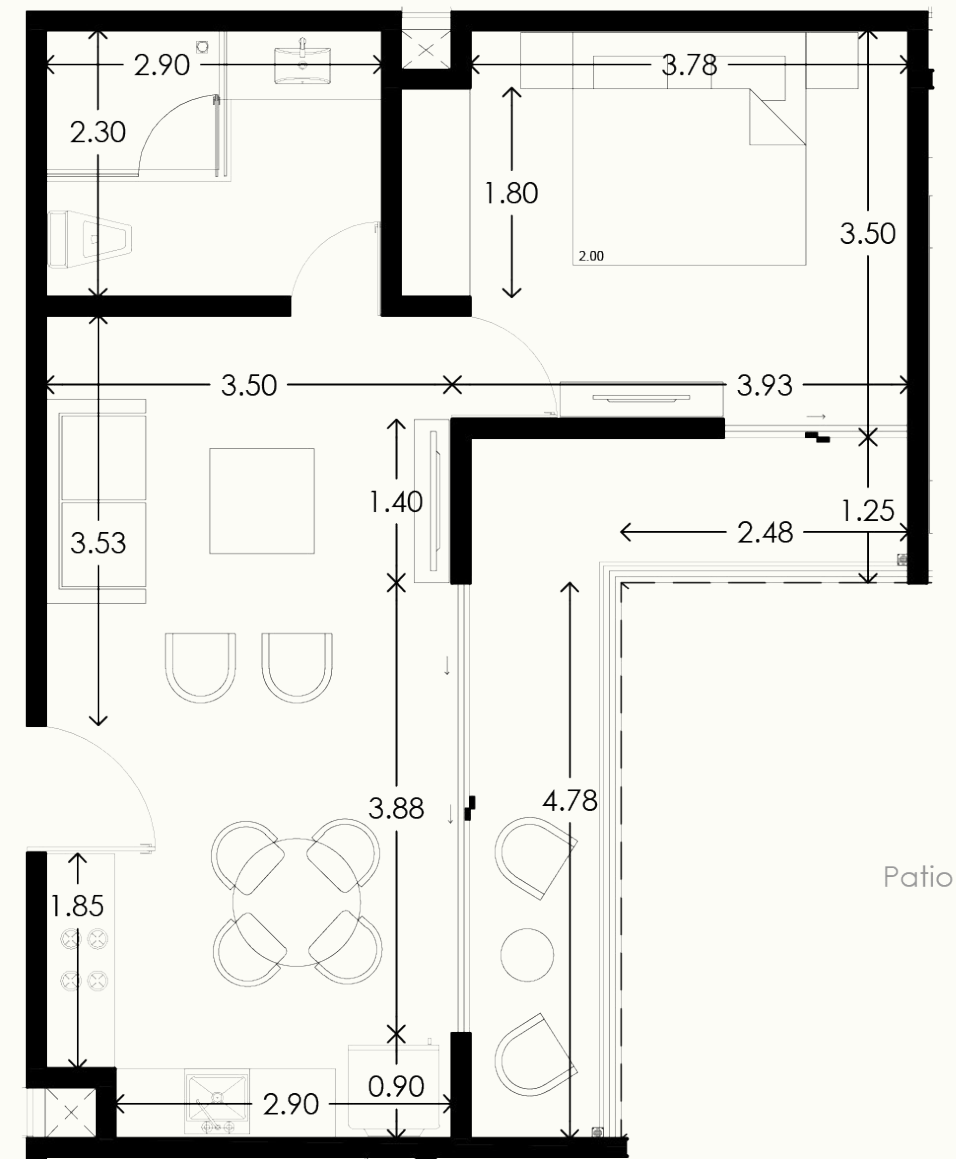

Departamento Tipo PH-A



Planta Baja



Planta Alta

Departamento Tipo PH-A

Tipo	PH-A
Habitaciones	3
Baño	3
Terraza Techada	7.14 m ²
Terraza no Techada	29.45 m ²
Superficie Interior	124.80 m ²
Total de superficie	161.39 m ²

Planta alta

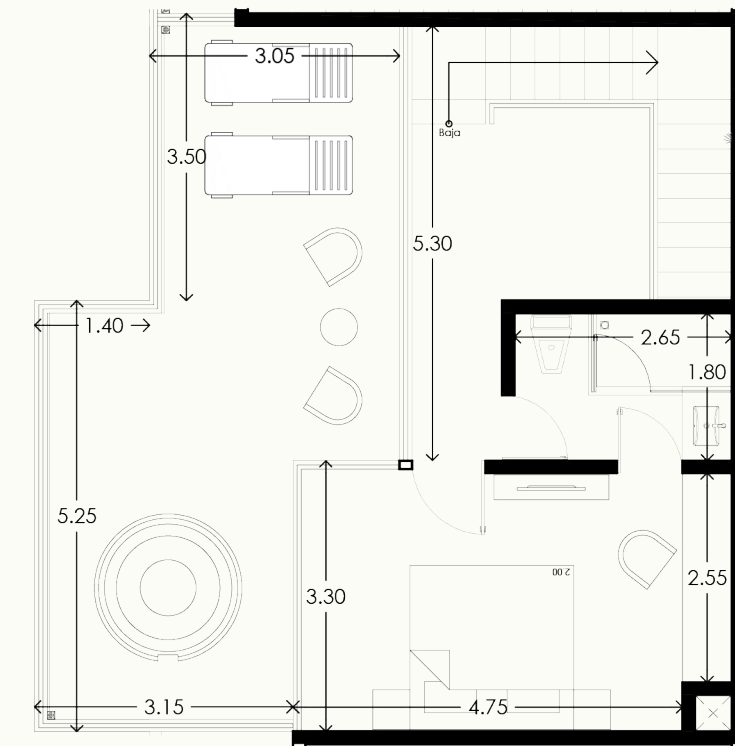
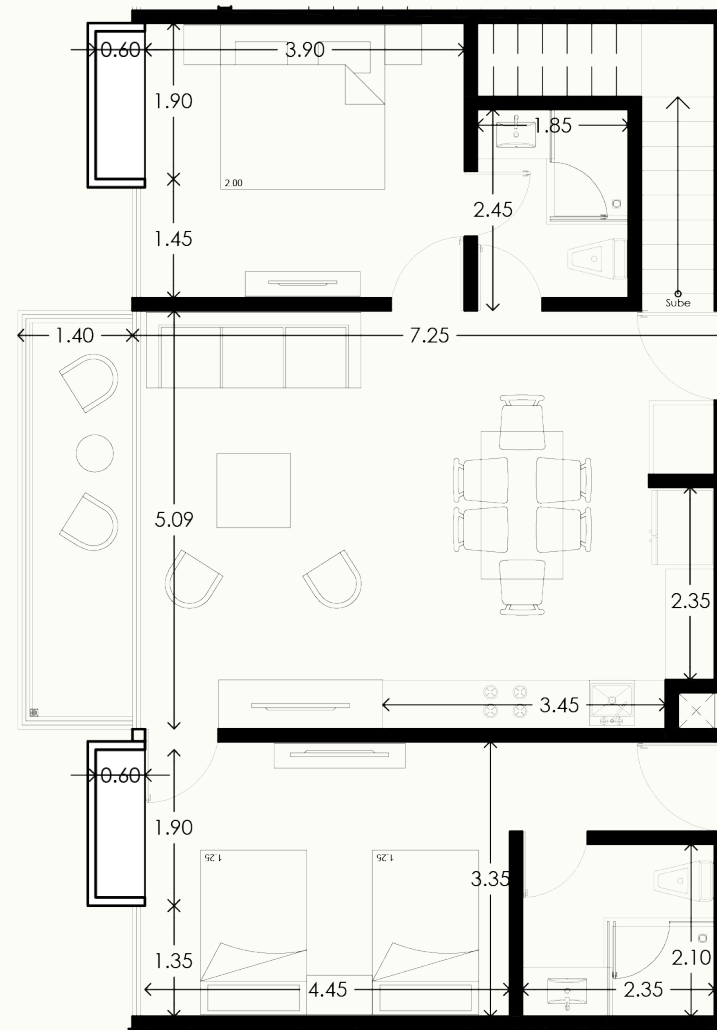

Departamento Tipo PH-B

Planta Baja



Planta Alta



Departamento Tipo PH-B

Tipo	PH-B
Habitaciones	3
Baño	3
Terraza Techada	15.20 m ²
Terraza no Techada	29.15 m ²
Superficie Interior	158.20 m ²
Total de superficie	202.55 m ²

Planta alta

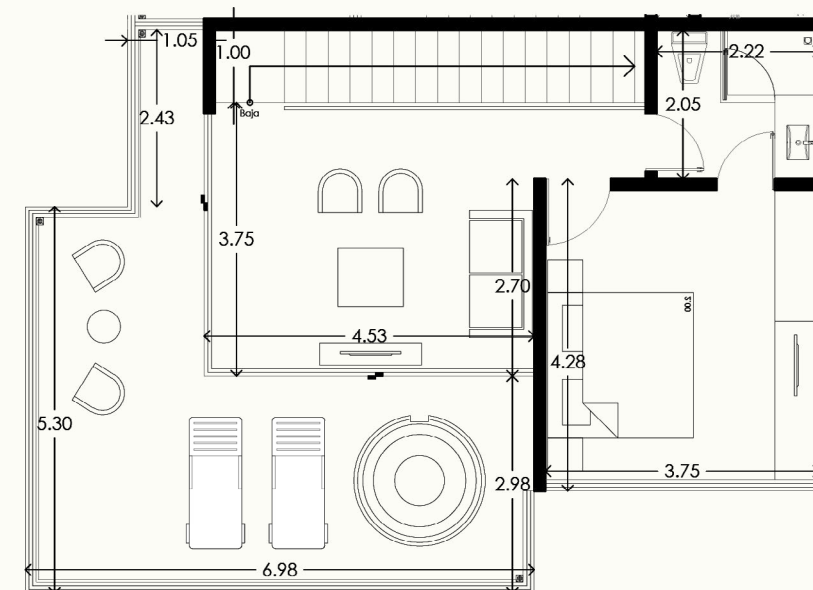
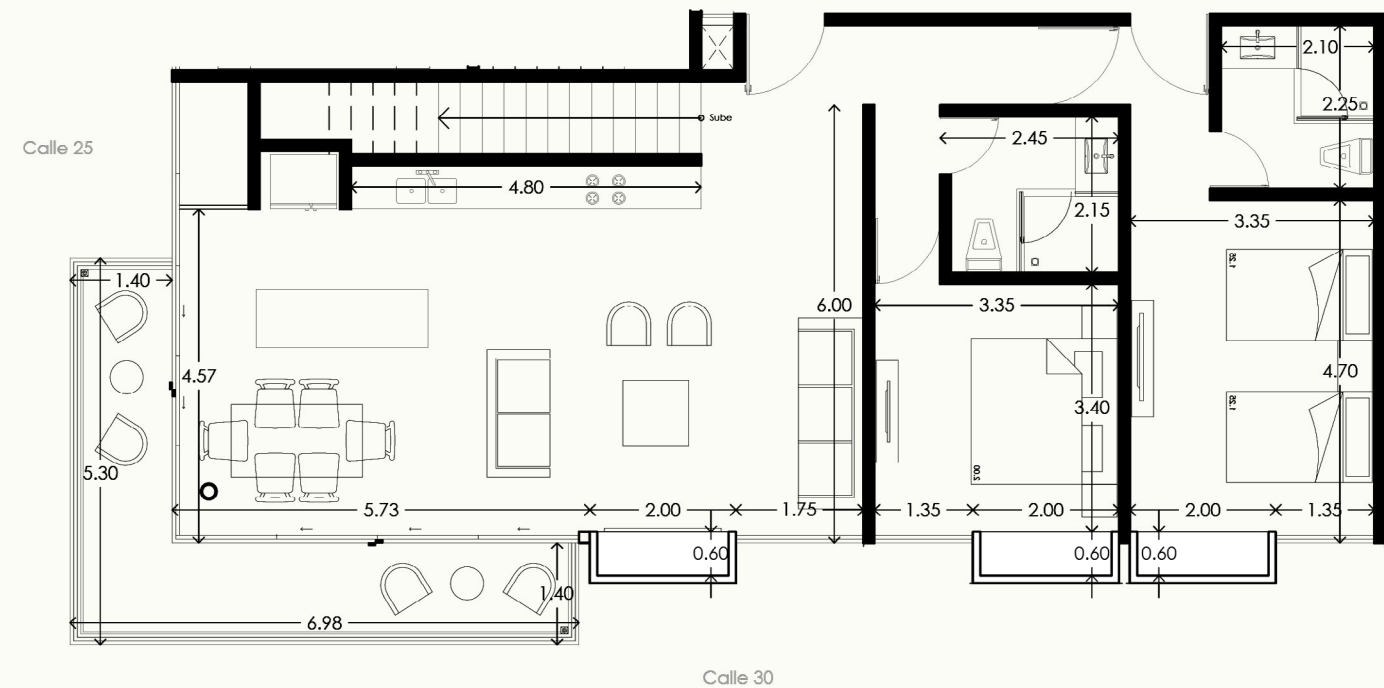

Ubicación



La ubicación es grandiosa, al estilo de vida que sólo se puede respirar en *Playa del Carmen*. Al correr las cortinas de tu habitación descubrirás un escenario natural y cultural excepcional.

Ubicado en la ZONA DORADA, a pasos de sus playas bañadas en arena blanca, el alucinante turquesa de sus aguas, y su icónica 5^{ta} Avenida, reconocida internacionalmente por su diversidad gastronómica y comercial.

